

contents

flat sided oval	4.1
rectangular	4.2
round	4.3
slimlock & micro puk blade	4.4
prongs, eurohooks & specials	4.5
shelf brackets and panel supports	4.6
specialist slatwall accessories	4.7



Slimline offer a range of accessories to suit your particular display requirements. When choosing your accessories, it is important to specify whether you plan to use the accessory in Slimline's aluminium system

or whether it is intended to be used in Slimline's steel modular systems simply because each system works with slightly different sized sections. Finishes include Epoxy Powder Coating, Bright Chrome, Brushed Satin Chrome and Mirror or Satin Stainless Steel. Slimline can manufacture accessories specifically to customers' requirements or they can be chosen from a standard range classed under seven distinct product classes.



This information is the strict copyright of Slimline Ltd and no portion should be used without written consent. We reserve the right to make changes to product specifications at any time. Slimline is a registered trade mark.

This information is the strict copyright of Slimline Ltd and no portion should be used without written consent. We reserve the right to make changes to product specifications at any time. Slimline is a registered trade mark.

SLIMLINE™ how to order an accessory

This section uses a key (see below) to identify system compatibility and can be found below each accessory.



For example. A round stepped arm 300mm long, code **SL553** required for slotted channels is: (see page 4.3 / 02)

SL553. **01**
 (Denotes part) (Denotes system)

Finishes are also denoted against each accessory as follows:

- BC** – Bright Chrome (Mirror)
- SC** – Satin Chrome (Brushed)
- SS** – Satin Stainless Steel (Brushed)
- PS** – Polished Stainless Steel (Mirror)
- PC** – Powder Coated Steel
- SA** – Silver Anodised

Therefore a round stepped arm 300mm long in Bright Chrome for slotted channel is **SL553.01.BC**

SL553. **01.** **BC**
 (Denotes part) (Denotes system) (Denotes Finish)

Please follow this procedure for ordering all accessories.

Most accessories are available in Chromed and Painted finishes with a limited range available in Stainless Steel.

If the required accessory is not depicted showing the system or finish you require, please enquire from us to see if it is possible.

Certain tube profiles cannot be obtained in Stainless Steel so often a Brushed Satin Chrome finish can be substituted to match other accessories required in a Satin Stainless steel finish.

We will also fabricate bespoke accessories to suit your individual requirements or designs. Please enquire for price and lead time on these.

Due to the thinner wall thickness of the mild steel slotted tubes please state when accessories are required for this system.

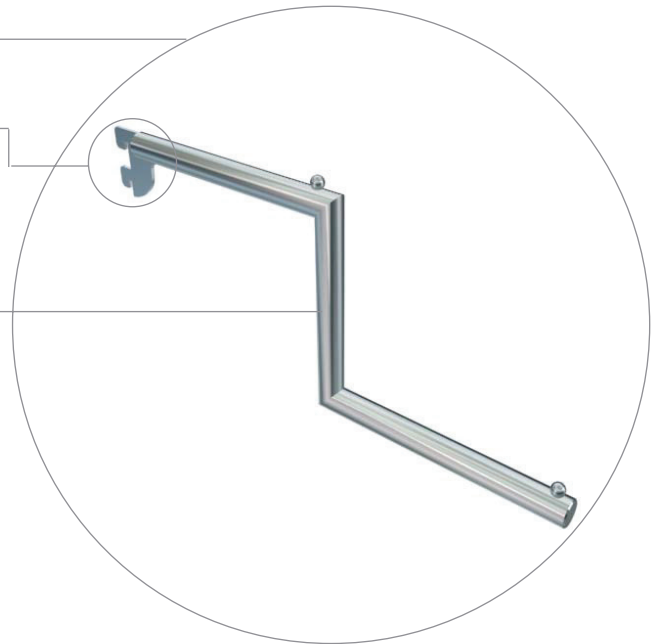

This information is the strict copyright of Slimline Ltd and no portion should be used without written consent. We reserve the right to make changes to product specifications at any time. Slimline is a registered trade mark.

SL200

FSD right hand rear support bracket for slotted post



01



BC / SC / PC

SL201

FSD left hand rear support bracket for slotted post



01



BC / SC / PC

SL202

FSD centre rear support bracket for slotted post

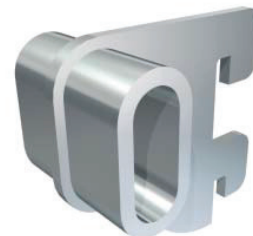

01



BC / SC / PC

SL203-205

FSD rear support bar to suit slot centres with fixed left end

Part No:	Length (to suit centres)
SL203	600mm
SL204	1000mm
SL205	1200mm



01



BC / SC / PC

FINISHES KEY:

BC - bright chrome

SC - satin chrome

SS - satin stainless steel

PS - polished stainless steel

PC - powder coated mild steel



This information is the strict copyright of Slimline Ltd and no portion should be used without written consent. We reserve the right to make changes to product specifications at any time. Slimline is a registered trade mark.

SL206-208

FSO rear support bar to suit slot centres with fixed right end

Part No:	Length (to suit centres)
SL206	600mm
SL207	1000mm
SL208	1200mm

01



BC / SC / PC



SL209-211

FSO rear support bar

Part No:	Length (to suit centres)
SL209	600mm
SL210	1000mm
SL211	1200mm

01

04

05

07



BC / SC / PC



SL212-214

FSO oversail rail with ball ends

Part No:	Length (to suit centres)
SL212	600mm
SL213	1000mm
SL214	1200mm

01

04

05

07



BC / SC / PC



SL215

Oversail rail support arm for FSO rail

01

04

05

07



BC / SC / PC



FINISHES KEY:

BC - bright chrome

SC - satin chrome

SS - satin stainless steel

PS - polished stainless steel

PC - powder coated mild steel



This information is the strict copyright of Slimline Ltd and no portion should be used without written consent. We reserve the right to make changes to product specifications at any time. Slimline is a registered trade mark.

SL216

Heavy duty oversail rail support arm for FSO rail on slotted posts



01



BC / SC / PC

SL217

Rear support rail holder for FSO rail



01

04

05

07



BC / SC / PC

SL218-220

FSO echelon rail with ball ends - left side projecting

Part No:	Length (to suit centres)
SL218	600mm
SL219	1000mm
SL220	1200mm



01

04

07



BC / SC / PC

SL221-223

FSO echelon rail with ball ends - right side projecting

Part No:	Length (to suit centres)
SL221	600mm
SL222	1000mm
SL223	1200mm



01

04

07



BC / SC / PC

FINISHES KEY:

BC - bright chrome

SC - satin chrome

SS - satin stainless steel

PS - polished stainless steel

PC - powder coated mild steel



This information is the strict copyright of Slimline Ltd and no portion should be used without written consent. We reserve the right to make changes to product specifications at any time. Slimline is a registered trade mark.

SL224-226

FSO fixed side hanging rail

Part No:	Length (to suit centres)
SL224	600mm
SL225	1000mm
SL226	1200mm



SL227-229

FSO heavy duty side hanging rail

Part No:	Length (to suit centres)
SL227	600mm
SL228	1000mm
SL229	1200mm



SL234-236

FSO D rail with ball ends

Part No:	Length (to suit centres)
SL234	600mm
SL235	1000mm
SL236	1200mm

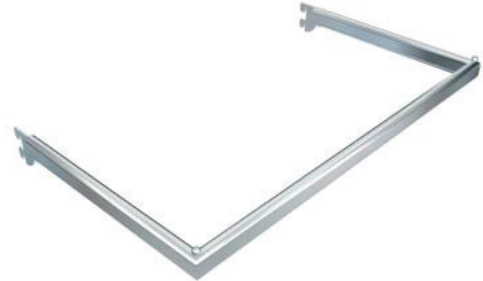

SL230

FSO T arm 600mm long with ball ends



FINISHES KEY:
BC - bright chrome

SC - satin chrome
SS - satin stainless steel

PS - polished stainless steel
PC - powder coated mild steel



This information is the strict copyright of Slimline Ltd and no portion should be used without written consent. We reserve the right to make changes to product specifications at any time. Slimline is a registered trade mark.

SL231

FSO double T arm 1200mm long with ball ends



SL232

FSO heavy duty T arm 600mm long with ball ends for slotted posts



SL233

FSO heavy duty T arm 1200mm long with ball ends for 600mm slot centres

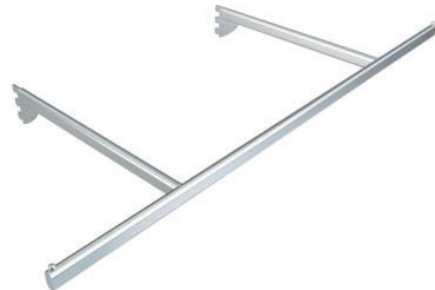

FINISHES KEY:
BC - bright chrome

SC - satin chrome
SS - satin stainless steel

PS - polished stainless steel
PC - powder coated mild steel



This information is the strict copyright of Slimline Ltd and no portion should be used without written consent. We reserve the right to make changes to product specifications at any time. Slimline is a registered trade mark.

SL500

FSO stub arm with ball end



01 02 04 07 08







BC / SC / PC

SL501-503

FSO forward arm with ball end

Part No:	Length
SL501	200mm
SL502	300mm
SL503	400mm



01 02 04 07 08







BC / SC / PC

SL504-505

FSO heavy duty forward arm with ball end for slotted posts

Part No:	Length
SL504	300mm
SL505	400mm



01



BC / SC / PC

SL506-507

FSO stepped arm with ball end

Part No:	Length
SL506	300mm
SL507	400mm



01 02 04 07 08







BC / SC / PC

FINISHES KEY:
BC - bright chrome

SC - satin chrome
SS - satin stainless steel

PS - polished stainless steel
PC - powder coated mild steel



This information is the strict copyright of Slimline Ltd and no portion should be used without written consent. We reserve the right to make changes to product specifications at any time. Slimline is a registered trade mark.

SL508-509

Heavy duty FSO stepped arm with ball end for slotted posts

Part No:	Length
SL508	300mm
SL509	400mm

01



BC / SC / PC



SL510-511

FSO sloping arm with balls

Part No:	Length
SL510	300mm
SL511	400mm

01

02

04

07

08



BC / SC / PC



SL512-513

FSO sloping handbag arm with hooks

Part No:	Length
SL512	300mm
SL513	400mm

01

02

04

07

08



BC / SC / PC

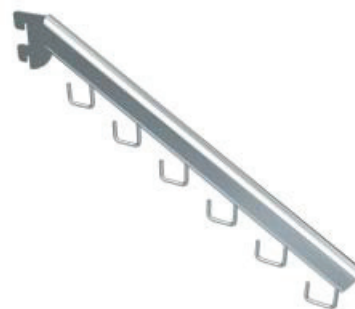

FINISHES KEY:

BC - bright chrome

SC - satin chrome

SS - satin stainless steel

PS - polished stainless steel

PC - powder coated mild steel



This information is the strict copyright of Slimline Ltd and no portion should be used without written consent. We reserve the right to make changes to product specifications at any time. Slimline is a registered trade mark.

SL523

Fineline stub arm with ball end



SL524-525

Fineline forward arm with ball end

Part No:	Length
SL524	200mm
SL525	300mm



SL526

Fineline stepped arm with ball end - 300mm long



SL527

Fineline sloping arm with ball end - 300mm long



FINISHES KEY:
BC - bright chrome

SC - satin chrome
SS - satin stainless steel

PS - polished stainless steel
PC - powder coated mild steel



This information is the strict copyright of Slimline Ltd and no portion should be used without written consent. We reserve the right to make changes to product specifications at any time. Slimline is a registered trade mark.

SL528

Fineline handbag arm with hooks

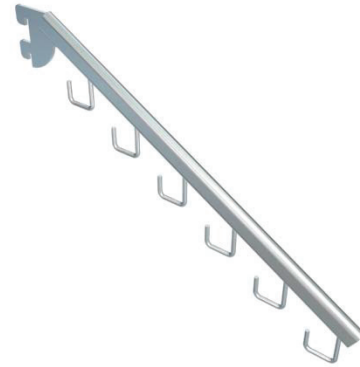

SL529

Fineline combination arm for shelving and hanging options



FINISHES KEY:
BC - bright chrome

SC - satin chrome
SS - satin stainless steel

PS - polished stainless steel
PC - powder coated mild steel



This information is the strict copyright of Slimline Ltd and no portion should be used without written consent. We reserve the right to make changes to product specifications at any time. Slimline is a registered trade mark.

SL244

Oversail rail support arm for rectangular oversail rail

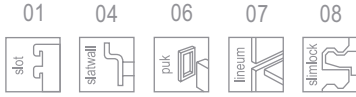

BC / SC / SS / PS / PC

SL245

Heavy duty oversail rail support arm for rectangular oversail rail



BC / SC / SS / PS / PC

SL246

Rear support rail holder for rectangular oversail rail

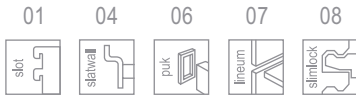

BC / SC / SS / PS / PC

SL247-249

Rectangular oversail rail with ball ends

Part No:	Length (to suit centres)
SL247	600mm
SL248	1000mm
SL249	1200mm

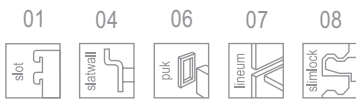

BC / SC / SS / PS / PC

FINISHES KEY:

BC - bright chrome

SC - satin chrome

SS - satin stainless steel

PS - polished stainless steel

PC - powder coated mild steel



This information is the strict copyright of Slimline Ltd and no portion should be used without written consent. We reserve the right to make changes to product specifications at any time. Slimline is a registered trade mark.

SL250-252

Rectangular rear support rail

Part No:	Length (to suit centres)
SL224	600mm
SL225	1000mm
SL226	1200mm

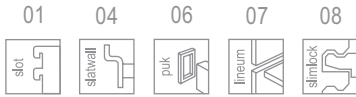

BC / SC / SS / PS / PC



SL253-255

Rectangular side hanging rail

Part No:	Length (to suit centres)
SL253	600mm
SL254	1000mm
SL255	1200mm

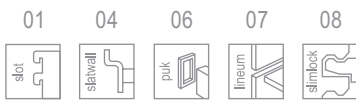

BC / SC / SS / PS / PC



SL256-258

Heavy duty rectangular side hanging rail

Part No:	Length (to suit centres)
SL256	600mm
SL257	1000mm
SL258	1200mm



SL269-271

Rectangular D rail

Part No:	Length (to suit centres)
SL269	600mm
SL270	1000mm
SL271	1200mm



BC / SC / SS / PS / PC



FINISHES KEY:
BC - bright chrome

SC - satin chrome
SS - satin stainless steel

PS - polished stainless steel
PC - powder coated mild steel



This information is the strict copyright of Slimline Ltd and no portion should be used without written consent. We reserve the right to make changes to product specifications at any time. Slimline is a registered trade mark.

SL259-261

Rectangular echelon rail with ball ends - left side projecting

Part No:	Length (to suit centres)
SL259	600mm
SL260	1000mm
SL261	1200mm

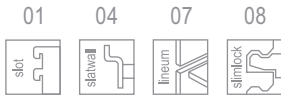

BC / SC / SS / PS / PC



SL262-264

Rectangular echelon rail with ball ends - right side projecting

Part No:	Length (to suit centres)
SL262	600mm
SL263	1000mm
SL264	1200mm

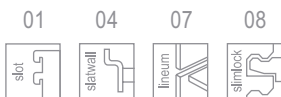

BC / SC / SS / PS / PC



SL265

Rectangular T arm 600mm long with ball ends

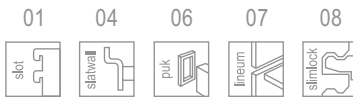

BC / SC / SS / PS / PC



SL266

Rectangular double T arm 1200mm long with ball ends



BC / SC / SS / PS / PC



FINISHES KEY:

BC - bright chrome

SC - satin chrome

SS - satin stainless steel

PS - polished stainless steel

PC - powder coated mild steel



This information is the strict copyright of Slimline Ltd and no portion should be used without written consent. We reserve the right to make changes to product specifications at any time. Slimline is a registered trade mark.

SL267

Rectangular heavy duty T arm 600mm long with ball ends for slotted posts

01



BC / SC / SS / PS / PC



SL268

Rectangular heavy duty T arm 1200mm long with ball ends for 600mm slot centres

01



BC / SC / SS / PS / PC



SL269-271

Rectangular D rail

Part No:	Length (to suit centres)
SL269	600mm
SL270	1000mm
SL271	1200mm

01



03



04



06



07



08



BC / SC / SS / PS / PC



FINISHES KEY:
BC - bright chrome

SC - satin chrome
SS - satin stainless steel

PS - polished stainless steel
PC - powder coated mild steel



This information is the strict copyright of Slimline Ltd and no portion should be used without written consent. We reserve the right to make changes to product specifications at any time. Slimline is a registered trade mark.

SL530

Rectangular stub arm with ball end



SL531-533

Rectangular forward arm with ball end

Part No:	Length
SL531	200mm
SL532	300mm
SL533	400mm

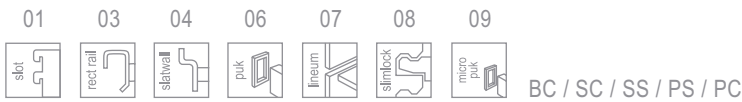

SL534-535

Rectangular heavy duty forward arm with ball end for slotted posts

Part No:	Length
SL534	300mm
SL535	400mm



SL536-537

Rectangular stepped arm with ball end

Part No:	Length
SL536	300mm
SL537	400mm



FINISHES KEY:
BC - bright chrome

SC - satin chrome
SS - satin stainless steel

PS - polished stainless steel
PC - powder coated mild steel



This information is the strict copyright of Slimline Ltd and no portion should be used without written consent. We reserve the right to make changes to product specifications at any time. Slimline is a registered trade mark.

SL538-539

Rectangular heavy duty stepped arm with balls for slotted posts

Part No:	Length
SL538	300mm
SL539	400mm

01



BC / SC / SS / PS / PC



SL540-541

Rectangular sloping arm with balls

Part No:	Length
SL540	300mm
SL541	400mm

01

03

04

06

07

08

09



BC / SC / SS / PS / PC



SL542-543

Rectangular combination arm for shelving and hanging options

Part No:	Length
SL542	300mm
SL543	400mm

01

03

04

06

07

08

09



BC / SC / SS / PS / PC

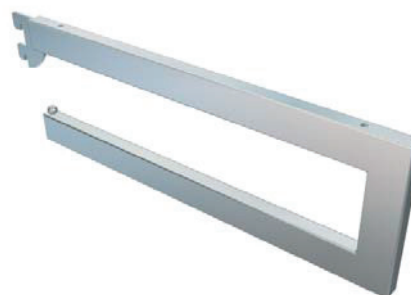

SL544-546

Rectangular shelf support arm

Part No:	Length
SL544	200mm
SL545	300mm
SL546	400mm

01

04

06

08

09



BC / SC / SS / PS / PC



FINISHES KEY:
BC - bright chrome

SC - satin chrome
SS - satin stainless steel

PS - polished stainless steel
PC - powder coated mild steel



This information is the strict copyright of Slimline Ltd and no portion should be used without written consent. We reserve the right to make changes to product specifications at any time. Slimline is a registered trade mark.

SL280

Round T arm 600mm long with ball ends



BC / SC / SS / PS / PC

SL281

Round double T arm 1200mm long with ball ends



BC / SC / SS / PS / PC

SL282-284

Round side hanging rail with ball ends

Part No:	Length (to suit centres)
SL282	600mm
SL283	1000mm
SL284	1200mm



BC / SC / SS / PS / PC

FINISHES KEY:
BC - bright chrome

SC - satin chrome
SS - satin stainless steel

PS - polished stainless steel
PC - powder coated mild steel



This information is the strict copyright of Slimline Ltd and no portion should be used without written consent. We reserve the right to make changes to product specifications at any time. Slimline is a registered trade mark.

SL550

Round stub arm with ball end



BC / SC / SS / PS / PC

SL551-552

Round forward arm with ball end

Part No:	Length
SL551	300mm
SL552	400mm



BC / SC / SS / PS / PC

SL553-554

Round stepped arm with ball end

Part No:	Length
SL553	300mm
SL554	400mm

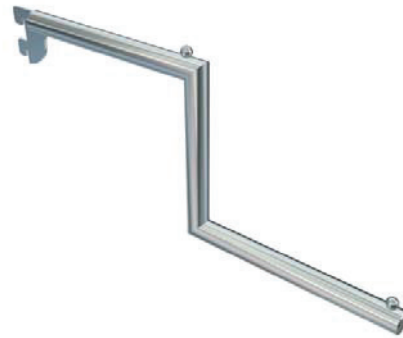

BC / SC / SS / PS / PC

SL555-556

Round sloping arm with ball end

Part No:	Length
SL555	300mm
SL556	400mm



BC / SC / SS / PS / PC

FINISHES KEY:
BC - bright chrome

SC - satin chrome
SS - satin stainless steel

PS - polished stainless steel
PC - powder coated mild steel



This information is the strict copyright of Slimline Ltd and no portion should be used without written consent. We reserve the right to make changes to product specifications at any time. Slimline is a registered trade mark.

SL557-558

Round combination arm for shelving and hanging options

Part No:	Length
SL557	300mm
SL558	400mm



BC / SC / SS / PS / PC

SL559-561

Round shelf support arm

Part No:	Length
SL559	200mm
SL560	300mm
SL561	400mm



BC / SC / SS / PS / PC

FINISHES KEY:
BC - bright chrome

SC - satin chrome
SS - satin stainless steel

PS - polished stainless steel
PC - powder coated mild steel



This information is the strict copyright of Slimline Ltd and no portion should be used without written consent. We reserve the right to make changes to product specifications at any time. Slimline is a registered trade mark.

SL570

Blade stub arm



BC / SC / SS / PS

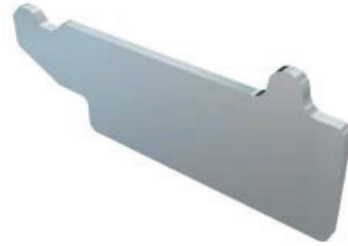

SL571-573

Blade forward arm

Part No:	Length
SL571	200mm
SL572	300mm
SL573	400mm



BC / SC / SS / PS



SL574-575

Blade stepped arm

Part No:	Length
SL574	300mm
SL575	400mm



BC / SC / SS / PS



SL576-577

Blade handbag arm

Part No:	Length
SL576	300mm
SL577	400mm



BC / SC / SS / PS

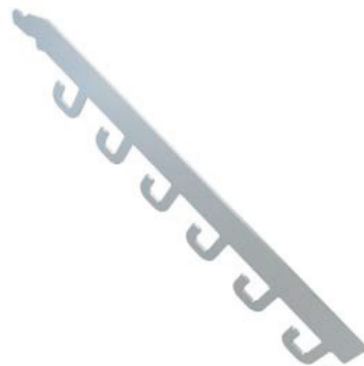

FINISHES KEY:

BC - bright chrome

SC - satin chrome

SS - satin stainless steel

PS - polished stainless steel

PC - powder coated mild steel

This information is the strict copyright of Slimline Ltd and no portion should be used without written consent. We reserve the right to make changes to product specifications at any time. Slimline is a registered trade mark.

SL578-579

Blade combination arm for shelving and hanging options

Part No:	Length
SL578	300mm
SL579	400mm

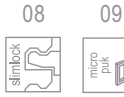

BC / SC / SS / PS

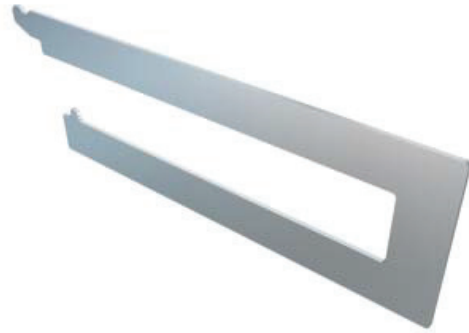

SL580-581

Blade stepped lingerie prong

Part No:	Length
SL580	200mm
SL581	300mm

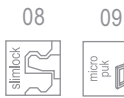

BC / SC / SS / PS



SL582-583

Blade sloping arm

Part No:	Length
SL582	300mm
SL583	400mm

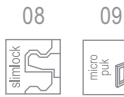

BC / SC / SS / PS



SL584-585

Blade shelf arm

Part No:	Length
SL584	250mm
SL585	350mm

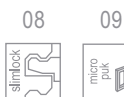

BC / SC / SS / PS

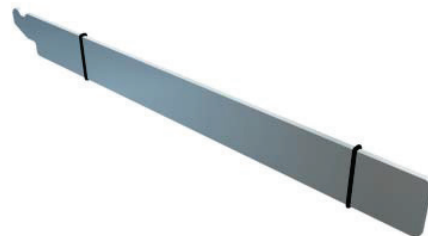

FINISHES KEY:

BC - bright chrome

SC - satin chrome

SS - satin stainless steel

PS - polished stainless steel

PC - powder coated mild steel

This information is the strict copyright of Slimline Ltd and no portion should be used without written consent. We reserve the right to make changes to product specifications at any time. Slimline is a registered trade mark.

SL597-601

Standard display prong in Ø6mm steel with 12mm disc end

Part No:	Length
SL597	100mm
SL598	150mm
SL599	200mm
SL600	250mm
SL601	300mm

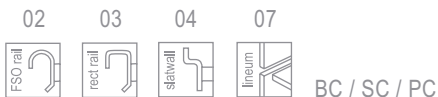

SL603-607

Heavy duty display prong in Ø8mm steel with 19mm disc end

Part No:	Length
SL603	100mm
SL604	150mm
SL605	200mm
SL606	250mm
SL607	300mm

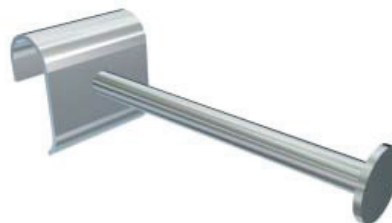

SL609-613

Display prong in Ø6mm steel with 45 degree domed end

Part No:	Length
SL609	100mm
SL610	150mm
SL611	200mm
SL612	250mm
SL613	300mm

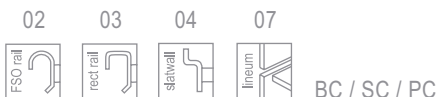

FINISHES KEY:
BC - bright chrome

SC - satin chrome
SS - satin stainless steel

PS - polished stainless steel
PC - powder coated mild steel

This information is the strict copyright of Slimline Ltd and no portion should be used without written consent. We reserve the right to make changes to product specifications at any time. Slimline is a registered trade mark.

SL615-616

Stepped lingerie prong in Ø6mm steel with ball end

Part No:	Length
SL615	200mm
SL616	300mm



BC / SC / PC



SL618-622

Standard eurohook in Ø5mm steel with upturned end

Part No:	Length
SL618	100mm
SL619	150mm
SL620	200mm
SL621	250mm
SL622	300mm



BC / SC / PC



SL624-628

Narrow 15mm eurohook in Ø5mm steel with upturned end

Part No:	Length
SL624	100mm
SL625	150mm
SL626	200mm
SL627	250mm
SL628	300mm



BC / SC / PC



FINISHES KEY:
BC - bright chrome

SC - satin chrome
SS - satin stainless steel

PS - polished stainless steel
PC - powder coated mild steel

This information is the strict copyright of Slimline Ltd and no portion should be used without written consent. We reserve the right to make changes to product specifications at any time. Slimline is a registered trade mark.

SL300-302

Standard left hand shelf bracket for slotted posts

Part No:	Length
SL300	100mm
SL301	200mm
SL302	300mm

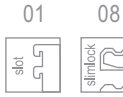

BC / SC / SS / PS / PC



SL303-305

Standard right hand shelf bracket for slotted posts

Part No:	Length
SL303	100mm
SL304	200mm
SL305	300mm

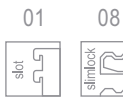

BC / SC / SS / PS / PC



SL306-308

Standard intermediate shelf bracket for slotted posts

Part No:	Length
SL306	100mm
SL307	200mm
SL308	300mm

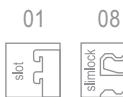

BC / SC / SS / PS / PC



SL309-311

Heavy duty left hand shelf bracket for slotted posts

Part No:	Length
SL309	250mm
SL310	350mm
SL311	450mm



BC / SC / SS / PS / PC



FINISHES KEY:

BC - bright chrome

SC - satin chrome

SS - satin stainless steel

PS - polished stainless steel

PC - powder coated mild steel

This information is the strict copyright of Slimline Ltd and no portion should be used without written consent. We reserve the right to make changes to product specifications at any time. Slimline is a registered trade mark.

SL312-314

Heavy duty right hand shelf bracket for slotted posts

Part No:	Length
SL312	250mm
SL313	350mm
SL314	450mm

01



BC / SC / SS / PS / PC



SL315-317

Heavy duty intermediate bracket for slotted posts

Part No:	Length
SL315	250mm
SL316	350mm
SL317	450mm

01



BC / SC / SS / PS / PC



SL319-321

Standard left hand oversail shelf bracket for slotted posts

Part No:	Length
SL319	100mm
SL320	200mm
SL321	300mm

01

08



BC / SC / SS / PS / PC



SL322-324

Standard right hand oversail shelf bracket for slotted posts

Part No:	Length
SL322	100mm
SL323	200mm
SL324	300mm

01

08



BC / SC / SS / PS / PC



FINISHES KEY:

BC - bright chrome

SC - satin chrome

SS - satin stainless steel

PS - polished stainless steel

PC - powder coated mild steel

This information is the strict copyright of Slimline Ltd and no portion should be used without written consent. We reserve the right to make changes to product specifications at any time. Slimline is a registered trade mark.

SL326-328

Heavy duty left hand oversail shelf bracket for slotted posts

Part No:	Length
SL326	250mm
SL327	350mm
SL328	450mm

01



BC / SC / SS / PS / PC



SL329-331

Heavy duty right hand oversail shelf bracket for slotted posts

Part No:	Length
SL329	250mm
SL330	350mm
SL331	450mm

01



BC / SC / SS / PS / PC



SL333-335

Sloping left hand shelf bracket for slotted posts

Part No:	Length
SL333	100mm
SL334	200mm
SL335	300mm

01

08



BC / SC / SS / PS / PC



SL336-338

Sloping right hand shelf bracket for slotted posts

Part No:	Length
SL336	100mm
SL337	200mm
SL338	300mm

01

08



BC / SC / SS / PS / PC



FINISHES KEY:

BC - bright chrome

SC - satin chrome

SS - satin stainless steel

PS - polished stainless steel

PC - powder coated mild steel

This information is the strict copyright of Slimline Ltd and no portion should be used without written consent. We reserve the right to make changes to product specifications at any time. Slimline is a registered trade mark.

SL339-341

Sloping intermediate shelf bracket for slotted posts

Part No:	Length
SL339	100mm
SL340	200mm
SL341	300mm

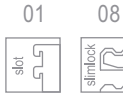

BC / SC / SS / PS / PC



SL343-345

Heavy duty sloping left hand shelf bracket for slotted posts

Part No:	Length
SL343	250mm
SL344	350mm
SL345	450mm



BC / SC / SS / PS / PC



SL346-348

Heavy duty sloping right hand shelf bracket for slotted posts

Part No:	Length
SL346	250mm
SL347	350mm
SL348	450mm



BC / SC / SS / PS / PC



SL349-351

Heavy duty sloping intermediate shelf bracket for slotted posts

Part No:	Length
SL349	250mm
SL350	350mm
SL351	450mm



BC / SC / SS / PS / PC



FINISHES KEY:

BC - bright chrome

SC - satin chrome

SS - satin stainless steel

PS - polished stainless steel

PC - powder coated mild steel

This information is the strict copyright of Slimline Ltd and no portion should be used without written consent. We reserve the right to make changes to product specifications at any time. Slimline is a registered trade mark.

SL353-355

Multi angle left hand shelf bracket for slotted posts

Part No:	Length (to suit centres)
SL353	250mm
SL354	350mm
SL355	450mm

01



BC / SC / SS / PS / PC



SL356-358

Multi angle right hand shelf bracket for slotted posts

Part No:	Length (to suit centres)
SL356	250mm
SL357	350mm
SL358	450mm

01



BC / SC / SS / PS / PC



SL359-361

Multi angle intermediate shelf bracket for slotted posts

Part No:	Length (to suit centres)
SL359	250mm
SL360	350mm
SL361	450mm

01



BC / SC / SS / PS / PC



FINISHES KEY:

BC - bright chrome

SC - satin chrome

SS - satin stainless steel

PS - polished stainless steel

PC - powder coated mild steel

This information is the strict copyright of Slimline Ltd and no portion should be used without written consent. We reserve the right to make changes to product specifications at any time. Slimline is a registered trade mark.

SL363-365

Designer left hand shelf bracket for slotted posts

Part No:	Length
SL363	150mm
SL364	250mm
SL365	350mm



01



BC / SC / SS / PS / PC

SL366-368

Designer right hand shelf bracket for slotted posts

Part No:	Length
SL366	50mm
SL367	250mm
SL368	350mm



01



BC / SC / SS / PS / PC

SL369-371

Designer intermediate shelf bracket for slotted posts

Part No:	Length
SL369	150mm
SL370	250mm
SL371	350mm



01



BC / SC / SS / PS / PC

SL373-375

Designer left hand oversail bracket for slotted posts

Part No:	Length
SL373	150mm
SL374	250mm
SL375	350mm



01



BC / SC / SS / PS / PC

FINISHES KEY:

BC - bright chrome

SC - satin chrome

SS - satin stainless steel

PS - polished stainless steel

PC - powder coated mild steel

This information is the strict copyright of Slimline Ltd and no portion should be used without written consent. We reserve the right to make changes to product specifications at any time. Slimline is a registered trade mark.

SL376-378

Designer right hand oversail bracket for slotted posts

Part No:	Length
SL376	150mm
SL377	250mm
SL378	350mm

01



BC / SC / SS / PS / PC



SL380-382

Designer sloping left hand bracket for slotted posts

Part No:	Length
SL380	150mm
SL381	250mm
SL382	350mm

01



BC / SC / SS / PS / PC



SL383-385

Designer sloping right hand bracket for slotted posts

Part No:	Length
SL383	150mm
SL384	250mm
SL385	350mm

01



BC / SC / SS / PS / PC



SL386-388

Designer sloping intermediate bracket for slotted posts

Part No:	Length
SL386	150mm
SL387	250mm
SL388	350mm

01



BC / SC / SS / PS / PC

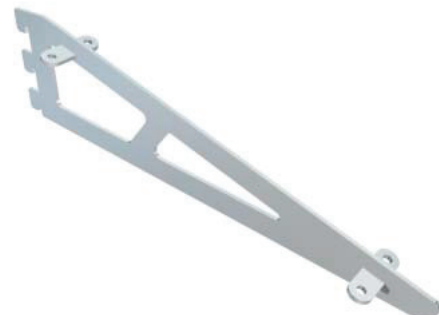

FINISHES KEY:

BC - bright chrome

SC - satin chrome

SS - satin stainless steel

PS - polished stainless steel

PC - powder coated mild steel

This information is the strict copyright of Slimline Ltd and no portion should be used without written consent. We reserve the right to make changes to product specifications at any time. Slimline is a registered trade mark.

SL395-396

Ultra slim shelf bracket for use with cam fixings

Part No:	Length
SL395	300mm
SL396	400mm



01



BC / SC / SS / PS / PC

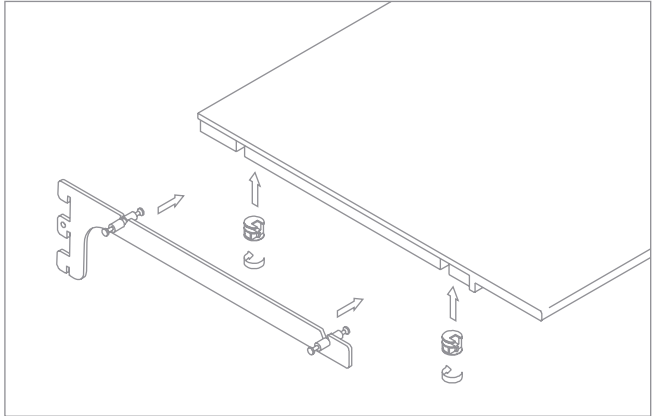

Typical fixing detail

SLIMLINE™ accessories - shelf brackets

- FINISHES KEY:
- BC - bright chrome
 - SC - satin chrome
 - PS - polished stainless steel
 - SS - satin stainless steel
 - PC - powder coated mild steel

This information is the strict copyright of Slimline Ltd and no portion should be used without written consent. We reserve the right to make changes to product specifications at any time. Slimline is a registered trade mark.

SL390-392

Glass/acrylic shelf support bar to suit slot centres

Part No:	Length (to suit centres)
SL390	600mm
SL391	1000mm
SL392	1200mm

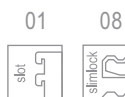

BC / SC / PC



SL902

Clear rubber sucker for use with shelf brackets for glass and acrylic



SL903

Acrylic / glass shelf retaining button component for up to 12mm thickness



BC / SC / PC

SL905

Pair of mild steel right angle panel retaining brackets for 32mm pitch slotted posts - left & right



BC / SC / SS / PS / PC

SL906

Pair of mild steel flat fixing brackets for 32mm pitch slotted posts - left & right

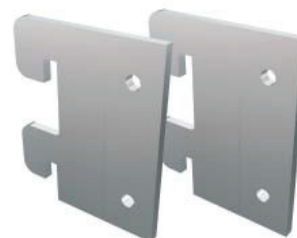

BC / SC / SS / PS / PC

FINISHES KEY:

BC - bright chrome

SC - satin chrome

SS - satin stainless steel

PS - polished stainless steel

PC - powder coated mild steel

This information is the strict copyright of Slimline Ltd and no portion should be used without written consent. We reserve the right to make changes to product specifications at any time. Slimline is a registered trade mark.

SL520

Ball arm with wire hoop

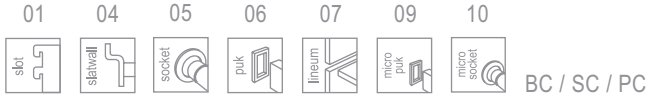

SL521

Double millinary arm with stepped positions

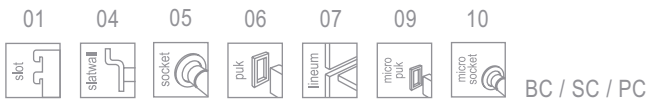

This information is the strict copyright of Slimline Ltd and no portion should be used without written consent. We reserve the right to make changes to product specifications at any time. Slimline is a registered trade mark.

SL912

Clear plastic panel retaining clip for slotted post - left handed version

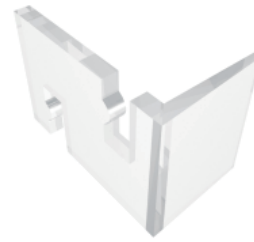

SL913

Clear plastic panel retaining clip for slotted post - right handed version



SL914

Clear plastic panel retaining clip for slotted post - centre version



SL915

Metal panel retaining clip for slotted post - left hand version



BC / SC / PC

SL916

Metal panel retaining clip for slotted post - right hand version



BC / SC / PC



This information is the strict copyright of Slimline Ltd and no portion should be used without written consent. We reserve the right to make changes to product specifications at any time. Slimline is a registered trade mark.

SL820-840

19mm veneered timber shelf with 2mm PVC edging

Part No:	Length (to suit centres)
SL820	600mm x 100mm
SL821	600mm x 200mm
SL822	600mm x 250mm
SL823	600mm x 300mm
SL824	600mm x 350mm
SL825	600mm x 400mm
SL826	600mm x 450mm
SL827	1000mm x 100mm
SL828	1000mm x 200mm
SL829	1000mm x 250mm
SL830	1000mm x 300mm
SL831	1000mm x 350mm
SL832	1000mm x 400mm
SL833	1000mm x 450mm
SL834	1200mm x 100mm
SL835	1200mm x 200mm
SL836	1200mm x 250mm
SL837	1200mm x 300mm
SL838	1200mm x 350mm
SL839	1200mm x 400mm
SL840	1200mm x 450mm



SL842-852

18mm Melamine faced timber shelf with 2mm PVC edging

Part No:	Length (to suit centres)
SL842	600mm x 100mm
SL843	600mm x 200mm
SL844	600mm x 250mm
SL845	600mm x 300mm
SL846	600mm x 350mm
SL847	600mm x 400mm
SL848	600mm x 450mm
SL849	1000mm x 100mm
SL850	1000mm x 200mm
SL851	1000mm x 250mm
SL852	1000mm x 300mm



SLIMLINE™ accessories - shelving options

This information is the strict copyright of Slimline Ltd and no portion should be used without written consent. We reserve the right to make changes to product specifications at any time. Slimline is a registered trade mark.

SL853-862

18mm Melamine faced timber shelf with 2mm PVC edging

Part No:	Length (to suit centres)
SL853	1000mm x 350mm
SL854	1000mm x 400mm
SL855	1000mm x 450mm
SL856	1200mm x 100mm
SL857	1200mm x 200mm
SL858	1200mm x 250mm
SL859	1200mm x 300mm
SL860	1200mm x 350mm
SL861	1200mm x 400mm
SL862	1200mm x 450mm



SL864-884

18mm painted MDF shelf

Part No:	Length (to suit centres)
SL864	600mm x 100mm
SL865	600mm x 200mm
SL866	600mm x 250mm
SL867	600mm x 300mm
SL868	600mm x 350mm
SL869	600mm x 400mm
SL870	600mm x 450mm
SL871	1000mm x 100mm
SL872	1000mm x 200mm
SL873	1000mm x 250mm
SL874	1000mm x 300mm
SL875	1000mm x 350mm
SL876	1000mm x 400mm
SL877	1000mm x 450mm
SL878	1200mm x 100mm
SL879	1200mm x 200mm
SL880	1200mm x 250mm
SL881	1200mm x 300mm
SL882	1200mm x 350mm
SL883	1200mm x 400mm
SL884	1200mm x 450mm



This information is the strict copyright of Slimline Ltd and no portion should be used without written consent. We reserve the right to make changes to product specifications at any time. Slimline is a registered trade mark.

SL925-945

6mm toughened glass shelves with polished edges

Part No:	Length (to suit centres)
SL925	600mm x 100mm
SL926	600mm x 200mm
SL927	600mm x 250mm
SL928	600mm x 300mm
SL929	600mm x 350mm
SL930	600mm x 400mm
SL931	600mm x 450mm
SL932	1000mm x 100mm
SL933	1000mm x 200mm
SL934	1000mm x 250mm
SL935	1000mm x 300mm
SL936	1000mm x 350mm
SL937	1000mm x 400mm
SL938	1000mm x 450mm
SL939	1200mm x 100mm
SL940	1200mm x 200mm
SL941	1200mm x 250mm
SL942	1200mm x 300mm
SL943	1200mm x 350mm
SL944	1200mm x 400mm
SL945	1200mm x 450mm



SL947-957

8mm toughened glass shelves with polished edges

Part No:	Length (to suit centres)
SL947	600mm x 100mm
SL948	600mm x 200mm
SL949	600mm x 250mm
SL950	600mm x 300mm
SL951	600mm x 350mm
SL952	600mm x 400mm
SL953	600mm x 450mm
SL954	1000mm x 100mm
SL955	1000mm x 200mm
SL956	1000mm x 250mm
SL957	1000mm x 300mm



SLIMLINE™ accessories - shelving options

This information is the strict copyright of Slimline Ltd and no portion should be used without written consent. We reserve the right to make changes to product specifications at any time. Slimline is a registered trade mark.

SL958-967

8mm toughened glass shelves with polished edges

Part No:	Length (to suit centres)
SL958	1000mm x 350mm
SL959	1000mm x 400mm
SL960	1000mm x 450mm
SL961	1200mm x 100mm
SL962	1200mm x 200mm
SL963	1200mm x 250mm
SL964	1200mm x 300mm
SL965	1200mm x 350mm
SL966	1200mm x 400mm
SL967	1200mm x 450mm



SL969-989

10mm toughened glass shelves with polished edges

Part No:	Length (to suit centres)
SL969	600mm x 100mm
SL970	600mm x 200mm
SL971	600mm x 250mm
SL972	600mm x 300mm
SL973	600mm x 350mm
SL974	600mm x 400mm
SL975	600mm x 450mm
SL976	1000mm x 100mm
SL977	1000mm x 200mm
SL978	1000mm x 250mm
SL979	1000mm x 300mm
SL980	1000mm x 350mm
SL981	1000mm x 400mm
SL982	1000mm x 450mm
SL983	1200mm x 100mm
SL984	1200mm x 200mm
SL985	1200mm x 250mm
SL986	1200mm x 300mm
SL987	1200mm x 350mm
SL988	1200mm x 400mm
SL989	1200mm x 450mm



This information is the strict copyright of Slimline Ltd and no portion should be used without written consent. We reserve the right to make changes to product specifications at any time. Slimline is a registered trade mark.

SL1000-1020

10mm clear acrylic shelf with polished edges

Part No:	Length (to suit centres)
SL1000	600mm x 100mm
SL1001	600mm x 200mm
SL1002	600mm x 250mm
SL1003	600mm x 300mm
SL1004	600mm x 350mm
SL1005	600mm x 400mm
SL1006	600mm x 450mm
SL1007	1000mm x 100mm
SL1008	1000mm x 200mm
SL1009	1000mm x 250mm
SL1010	1000mm x 300mm
SL1011	1000mm x 350mm
SL1012	1000mm x 400mm
SL1013	1000mm x 450mm
SL1014	1200mm x 100mm
SL1015	1200mm x 200mm
SL1016	1200mm x 250mm
SL1017	1200mm x 300mm
SL1018	1200mm x 350mm
SL1019	1200mm x 400mm
SL1020	1200mm x 450mm



SL1022-1032

10mm clear silicone green edge acrylic shelf with polished edges

Part No:	Length (to suit centres)
SL1022	600mm x 100mm
SL1023	600mm x 200mm
SL1024	600mm x 250mm
SL1025	600mm x 300mm
SL1026	600mm x 350mm
SL1027	600mm x 400mm
SL1028	600mm x 450mm
SL1029	1000mm x 100mm
SL1030	1000mm x 200mm
SL1031	1000mm x 250mm
SL1032	1000mm x 300mm



This information is the strict copyright of Slimline Ltd and no portion should be used without written consent. We reserve the right to make changes to product specifications at any time. Slimline is a registered trade mark.

SL1033-1042

10mm clear silicone green edge acrylic shelf with polished edges

Part No:	Length (to suit centres)
SL1033	1000mm x 350mm
SL1034	1000mm x 400mm
SL1035	1000mm x 450mm
SL1036	1200mm x 100mm
SL1037	1200mm x 200mm
SL1038	1200mm x 250mm
SL1039	1200mm x 300mm
SL1040	1200mm x 350mm
SL1041	1200mm x 400mm
SL1042	1200mm x 450mm



SL1050-1070

Folded metal shelf. Painted finish

Part No:	Length (to suit centres)
SL1050	600mm x 100mm
SL1051	600mm x 200mm
SL1052	600mm x 250mm
SL1053	600mm x 300mm
SL1054	600mm x 350mm
SL1055	600mm x 400mm
SL1056	600mm x 450mm
SL1057	1000mm x 100mm
SL1058	1000mm x 200mm
SL1059	1000mm x 250mm
SL1060	1000mm x 300mm
SL1061	1000mm x 350mm
SL1062	1000mm x 400mm
SL1063	1000mm x 450mm
SL1064	1200mm x 100mm
SL1065	1200mm x 200mm
SL1066	1200mm x 250mm
SL1067	1200mm x 300mm
SL1068	1200mm x 350mm
SL1069	1200mm x 400mm
SL1070	1200mm x 450mm



This information is the strict copyright of Slimline Ltd and no portion should be used without written consent. We reserve the right to make changes to product specifications at any time. Slimline is a registered trade mark.

SL630

Flat steel shoe shelf 330mm x 110mm
painted finish

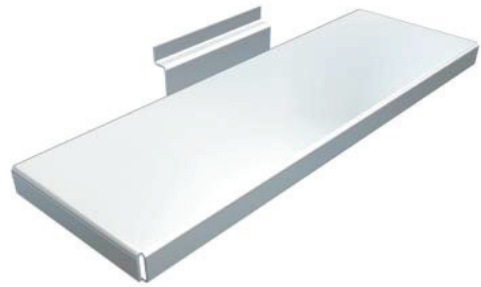

04



PC

SL631

Left sloping steel shoe shelf 330mm x 110mm
painted finish



04



PC

SL632

Right sloping steel shoe shelf 330mm x 110mm
painted finish



04



PC

SL641

A4 portrait sloping steel brochure shelf
230mm wide x 330mm deep
painted finish



04



PC

FINISHES KEY:

BC - bright chrome

SC - satin chrome

SS - satin stainless steel

PS - polished stainless steel

PC - powder coated mild steel



This information is the strict copyright of Slimline Ltd and no portion should be used without written consent. We reserve the right to make changes to product specifications at any time. Slimline is a registered trade mark.

SL637-640

Sloping steel shelf - painted finish

Part No:	Size
SL637	600mm w x 250mm deep
SL638	1000mm w x 250mm deep
SL639	600mm w x 350mm deep
SL640	1000mm w x 350mm deep

04



PC

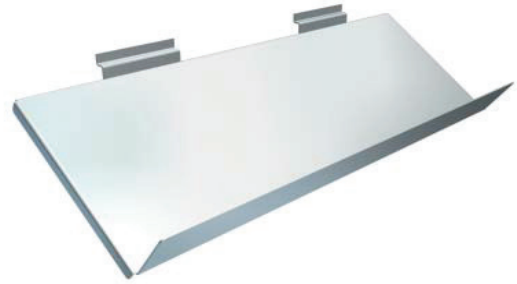

SL633-636

Flat steel shoe shelf - painted finish

Part No:	Size
SL633	600mm w x 200mm deep
SL634	1000mm w x 200mm deep
SL635	600mm w x 300mm deep
SL636	1000mm w x 300mm deep

04



PC

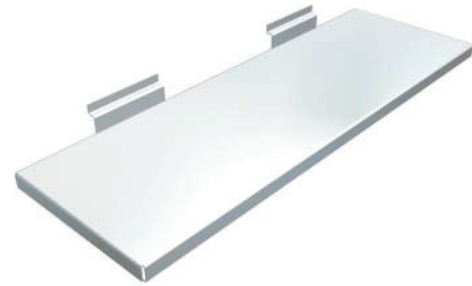

SL642-645

Steel tray - painted finish

Part No:	Size
SL642	600mm w x 100mm deep x 70mm h
SL643	1000mm w x 100mm deep x 70mm h
SL644	600mm w x 200mm deep x 70mm h
SL645	1000mm w x 200mm deep x 70mm h

04



PC



FINISHES KEY:
BC - bright chrome

SC - satin chrome
SS - satin stainless steel

PS - polished stainless steel
PC - powder coated mild steel



This information is the strict copyright of Slimline Ltd and no portion should be used without written consent. We reserve the right to make changes to product specifications at any time. Slimline is a registered trade mark.

SL800

Flat 3mm acrylic shoe shelf with ticket strip
250mm wide x 100mm deep



SL801

Left sloping 3mm acrylic shoe shelf
270mm wide x 100mm deep x 50mm high



SL802

Right sloping 3mm acrylic shoe shelf
270mm wide x 100mm deep x 50mm high



SL803

Front sloping 3mm acrylic shoe shelf
300mm deep x 90mm wide x 50mm high



This information is the strict copyright of Slimline Ltd and no portion should be used without written consent. We reserve the right to make changes to product specifications at any time. Slimline is a registered trade mark.

SL804

Angled A4 portrait 3mm acrylic brochure shelf with 30mm lip 230mm wide x 330mm deep



SL805-806

Heavy duty 6mm acrylic shelf with front lip

Part No:	Size
SL805	500mm w x 150mm deep
SL806	500mm w x 300mm deep



SL807

Heavy duty acrylic sloping shelf 500mm wide x 300mm deep with front lip



SL808

4mm bonded acrylic display tray 250mm wide x 310mm deep x 60mm high



This information is the strict copyright of Slimline Ltd and no portion should be used without written consent. We reserve the right to make changes to product specifications at any time. Slimline is a registered trade mark.

SL809

4mm bonded acrylic display box open top
200mm wide x 100mm deep x 150mm high



SL810-813

3mm clear acrylic folded panel pocket
with polished edges

Part No:	Size
SL810	A5 portrait
SL811	A4 portrait
SL812	A3 portrait
SL813	A2 portrait



SL814-816

3mm clear acrylic leaflet dispenser
with polished edges

Part No:	Size
SL814	Third A4/DL
SL813	A5 portrait
SL616	A4 portrait

